

## YL MG9 Mechanical Seal for Clean Water Pumps, Circulating Pumps and Vacuum Pumps YL MG9型机械密封

**Structural Features:** single end, unbalanced, independent direction of rotation, rubber bellow transmission. This component has a compact structure with good compatibility and easy installation. The bellow and the spring provide pressure compensation to the sealing faces. The rubber bellow design can prevent radial runout so the floatability of the rotary ring is increased.

**结构特点:** 单端面、非平衡型、任意旋向、橡胶波纹管传动。结构紧凑，兼容性较强，安装方便。波纹管与弹簧提供压力补偿使密封端面贴合更加紧密；波纹管可补偿轴的径向跳动，提高了动环的浮动性。

**Standards:** DIN24250, ISO3069, GB6556, EN12756  
**符合标准:** DIN24250, ISO3069, GB6556, EN12756

**Scopes of Application:** widely used in centrifugal pumps, piping pumps, sewage pumps, immersible motors, piping pumps, screw pumps, vacuum equipment and other rotary devices for sewage treatment, city water supply, chemical engineering, pharmacy, food processing, and paper making.  
**应用领域:** 广泛应用于污水处理、市政、供排水、化工、制药、食品、造纸等领域。可同清水泵、管道泵、螺杆泵、污水泵、潜水电机、真空设备等旋转设备配套。

**Inner Diameter:** 10 mm to 100 mm  
**规格范围:** 10 mm - 100 mm

### Materials

Rotary Ring Face: Carbon/SiC/TC

Stationary Ring Face: Al<sub>2</sub>O<sub>3</sub>/SiC/TC

Elastomers: NBR/EPDM/Viton

Springs: SS304/SS316

Metal Parts: SS304/SS316

### 材料

旋转环端面: 石墨/碳化硅/碳化钨

静止环端面: 氧化铝/碳化硅/碳化钨

辅助密封: 丁腈橡胶/三元乙丙胶/氟橡胶

弹簧: SS304/SS316

金属部件: SS304/SS316

### Operation Parameters

Pressure: ≤ 0.8 MPa

Temperature: -20 ~ 90 °C

Linear Speed: ≤ 10 m/s

### 运行参数

压力: ≤ 0.8 MPa

温度: -20 ~ 90 °C

线速度: ≤ 10 m/s

**Mediums:** oil, water, sewage, food and beverage, paper pulp and other weak-corrosion content.

**适用介质:** 油、水、污水、食品、纸浆等弱腐蚀性介质。

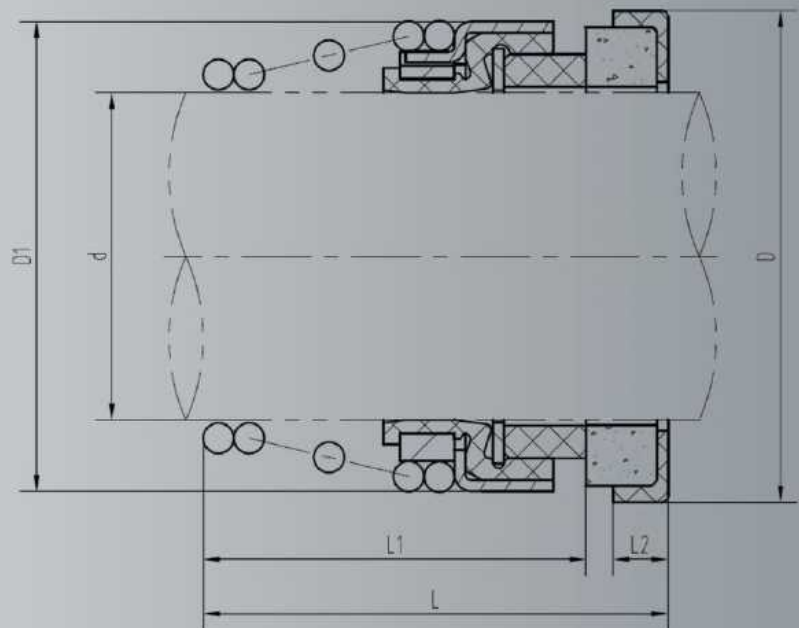

## YL MG9 Mechanical Seal Dimension Chart - YL MG9型机械密封尺寸对照表

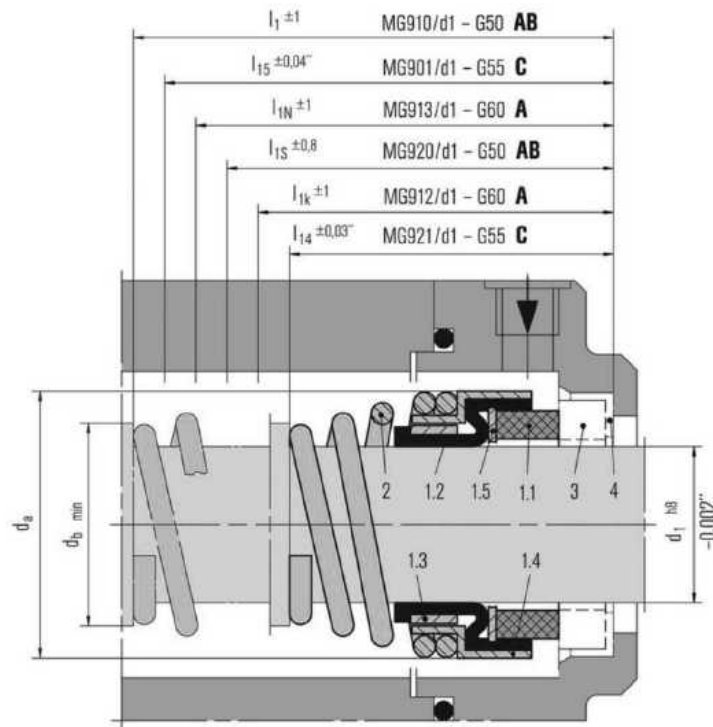

d1	d6	d7	d14	d16	da	db	l1	l1k	l1N	l1S	l5	l6	l17	l28	l29
10	17	21	11.0	24.60	19.6	13.0	53.0	32.5	40	34.0	1.5	4	7.5	6.6	9.0
12	19	23	13.5	27.80	21.6	15.0	53.0	32.5	40	34.0	1.5	4	7.5	6.6	9.0
14	21	25	17.0	30.95	24.0	18.0	54.5	35.0	40	35.5	1.5	4	9.0	6.6	10.5
15	-	-	17.0	30.95	25.0	19.0	54.5	-	-	35.5	-	-	9.0	-	10.5
16	23	27	17.0	30.95	26.5	20.0	54.5	35.0	40	35.5	1.5	4	9.0	6.6	10.5
18	27	33	20.0	34.15	29.0	22.0	54.5	37.5	45	35.5	2.0	5	9.0	7.5	10.5
20	29	35	21.5	35.70	31.5	24.5	54.5	37.5	45	35.5	2.0	5	9.0	7.5	10.5
22	31	37	23.0	37.30	33.0	27.0	54.5	37.5	45	35.5	2.0	5	9.0	7.5	10.5
24	33	39	26.5	40.50	37.0	29.0	54.5	40.0	50	35.5	2.0	5	9.0	7.5	10.5
25	34	40	26.5	40.50	38.0	30.0	54.5	40.0	50	35.5	2.0	5	9.0	7.5	10.5
28	37	43	29.5	47.65	41.0	34.0	72.0	42.5	50	45.0	2.0	5	10.5	7.5	12.0
30	39	45	32.5	50.80	43.0	36.0	72.0	42.5	50	45.0	2.0	5	10.5	7.5	12.0
32	42	48	32.5	50.80	45.0	38.0	72.0	42.5	55	45.0	2.0	5	10.5	7.5	12.0
33	42	48	36.5	54.00	46.0	39.0	72.0	42.5	55	45.0	2.0	5	10.5	7.5	12.0
35	44	50	36.5	54.00	48.0	41.0	72.0	42.5	55	45.0	2.0	5	10.5	7.5	12.0
38	49	56	39.5	57.15	52.5	44.5	72.0	45.0	55	45.0	2.0	6	10.5	9.0	12.0
40	51	58	42.5	60.35	55.5	47.5	72.0	45.0	55	45.0	2.0	6	10.5	9.0	12.0
43	54	61	46.0	63.50	58.5	50.5	83.0	45.0	60	53.0	2.0	6	10.5	9.0	12.0
45	56	63	46.0	63.50	60.5	52.5	83.0	45.0	60	53.0	2.0	6	10.5	9.0	12.0
48	59	66	49.0	66.70	64.0	56.0	83.0	45.0	60	53.0	2.0	6	10.5	9.0	12.0
50	62	70	52.0	69.85	66.0	58.0	84.5	47.5	60	54.5	2.5	6	12.0	9.5	13.5
53	65	73	55.5	73.05	69.0	61.0	84.5	47.5	70	54.5	2.5	6	12.0	11.0	13.5
55	67	75	58.5	76.20	71.0	63.0	84.5	47.5	70	54.5	2.5	6	12.0	11.0	13.5
58	70	78	61.5	79.40	76.0	66.0	84.5	52.5	70	54.5	2.5	6	12.0	11.0	13.5
60	72	80	61.5	79.40	78.0	68.0	84.5	52.5	70	54.5	2.5	6	12.0	11.0	13.5
63	75	83	65.0	82.55	82.0	71.5	84.5	52.5	70	54.5	2.5	6	12.0	11.0	13.5
65	77	85	68.0	82.55	84.0	73.5	86.0	52.5	80	65.0	2.5	6	14.5	11.0	16.0
68	81	90	71.0	95.25	87.0	76.5	86.0	52.5	80	65.0	2.5	7	14.5	11.3	16.0
70	83	92	71.0	95.25	89.0	79.0	86.0	60.0	80	65.0	2.5	7	14.5	11.3	16.0
75	88	97	77.5	101.60	95.0	85.0	89.0	60.0	80	68.0	2.5	7	14.5	11.3	16.0
80	95	105	84.0	114.30	101.5	91.5	99.0	60.0	90	76.0	3.0	7	18.5	12.0	20.0
85	100	110	87.0	117.50	107.0	97.0	99.0	60.0	90	76.0	3.0	7	18.5	14.0	20.0
90	105	115	93.5	123.85	111.5	103.0	103.0	65.0	90	79.0	3.0	7	18.5	14.0	20.0
95	110	120	96.5	127.00	117.5	108.0	103.0	65.0	90	79.0	3.0	7	18.5	14.0	20.0
100	115	125	103.0	133.35	122.5	114.0	106.0	65.0	90	82.0	3.0	7	18.5	14.0	20.0